

**CLASSICAL USB TURNTABLE WITH  
CD, AM/FM RADIO, CASSETTE**

 **PYLE<sup>®</sup> PRO**  
**VINTAGE**  
[www.pyleaudio.com](http://www.pyleaudio.com)

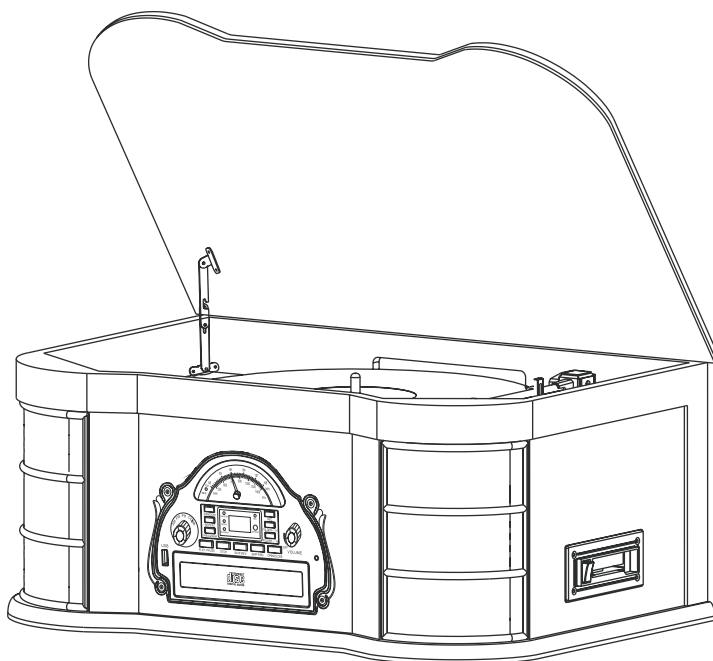

**MEDEL: PTCDS1U**  
**Nostalgic Music System**  
**Operating Instructions Manual**

# CAUTION

TO PREVENT FIRE OR SHOCK HAZARD, DO NOT USE THIS PLUG WITH AN EXTENSION CORD, RECEPTACLE OR OTHER OUTLET UNLESS THE BLADES CAN BE FULLY INSERTED TO PREVENT BLADE EXPOSURE. TO PREVENT FIRE OR SHOCK HAZARD, DO NOT EXPOSE THIS APPLIANCE TO RAIN OR MOISTURE.



The lightning flash with arrow-head symbol, within an equilateral triangle is intended to alert the user to the presence of uninsulated 'dangerous voltage' within the product's enclosure that may be of sufficient magnitude to constitute a risk of electric shock to persons.

## CAUTION

RISK OF ELECTRIC SHOCK  
DO NOT OPEN

WARNING: TO REDUCE THE RISK OF ELECTRIC SHOCK DO NOT REMOVE COVER (OR BACK), NO USER SERVICEABLE PARTS INSIDE REFER SERVICING TO QUALIFIED SERVICE PERSONNEL.



The exclamation point within an equilateral triangle is intended to alert the user to the presence of important operating and maintenance (servicing) instructions in the literature accompanying the appliance.

## IMPORTANT SAFETY INSTRUCTIONS

- 1) Please read these instructions and keep them for future reference.
- 2) Pay attention to all warnings.
- 3) Follow all instructions.
- 4) Do not use this apparatus near water.
- 5) Clean only with a dry cloth.
- 6) Do not block any ventilation openings.
- 7) Install in accordance with the manufacturer's instructions.  
Do not install near any heat sources such as radiators, heaters, stoves, or other apparatus (including amplifiers) that produce heat.
- 8) Protect the power cord from being walked on or kinked, in particular where the plug is fitted and at the point where it exits from the apparatus.
- 9) Only use attachments / accessories specified by the manufacturer.
- 10) Unplug this apparatus during lightning storms or when unused for long periods of time.
- 11) Refer all servicing to qualified service personnel. Servicing is required when the apparatus has been damaged in any way, such as power-supply cord or plug is damaged, liquid has been spilled or objects have fallen into the apparatus, the apparatus has been exposed to rain or moisture, does not operate normally, or has been dropped.
- 12) This appliance should not be exposed to dripping or splashing water and no object filled with liquids, such as vases, should be placed on the apparatus.
- 13) Do not overload the wall power outlet. Use only power source as indicated - i.e. 120V AC mains.

## IMPORTANT NOTES

Avoid installing this unit in places exposed to direct sunlight or close to heat radiating appliances such as electric heaters, on top of other stereo equipment that radiates too much heat, places lacking ventilation or dusty areas, places subject to constant vibration and/or humid or moist areas.

Do not attempt to clean this unit with chemical solvents as this might damage the finish. Use a clean dry cloth. Operate controls and switches as described in the manual. Before turning On the power, make certain the AC power cord is plugged in. Store your CDs, In a cool area to avoid damage from heat. When moving the set, be sure to first disconnect the power cord.

## PREPARATION FOR USE UNPACKING AND SET UP

- Carefully remove the unit from the display carton and remove all packing material from the unit.
- Unwind the AC power cord and extend it to its full length.
- Unwind the FM Antenna wire and extend it to its full length.
- Place the unit on a stable, level surface, convenient to an AC outlet, out of Direct sunlight, and away from sources of excess heat, dust, moisture, humidity or strong magnetic fields.
- Raise the lid to expose the phonograph. The phonograph has been secured for shipment with a transit screw. Use a coin or screwdriver to turn the transit screw clockwise. This will allow the Turntable to "float".
- Remove the opaque white plastic stylus cover from the phonograph stylus by sliding it Forward and down.
- Discard the stylus cover.
- Remove the twist-tie that was used to secure the tone arm during shipment.
- Release the tone arm lock lever.
- Connect the plug to your AC outlet.

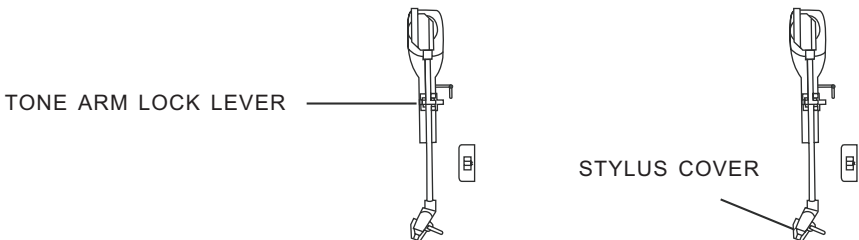
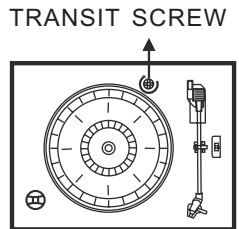

## POWER SOURCE

This product is designed to operate on 120V 60Hz AC only. Attempting to operate this system from any other power source may cause damage to the system, and such damage is not covered by your warranty.

NOTE: You will note that this system is equipped with domestic standard AC power 2-pin plug. If this plug does not fit into your existing AC outlet, do not try to defeat this safety feature by filing the wide blade to make it fit into your outlet. If this plug will not fit into your outlet, you probably have an outdated non-polarized AC outlet. You should have your outlet changed by a qualified licensed electrician.

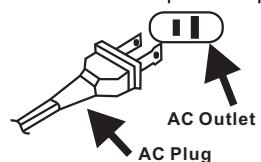

## PROTECT YOUR FURNITURE

This model is equipped with non-skid rubber 'feet' to prevent the product from moving when you operate the controls. These 'feet' are made from non-migrating rubber material specially formulated to avoid leaving any marks or stains on your furniture. However certain types of oil based furniture polishes, wood preservatives, or cleaning sprays may cause the rubber 'feet' to soften, and leave marks or a rubber residue on the furniture.

To prevent any damage to your furniture we strongly recommend that you purchase small self-adhesive felt pads, available at hardware stores and home improvement centers everywhere, and apply these pads to the bottom of the rubber 'feet' before you place the product on fine wooden furniture.

**IMPORTANT: Raising and Lowering the Lid**

To open the lid, raise it as far as it will go until the lid support bracket locks in the open position.

To close the lid, lift it upward slightly until the lid support bracket unlocks, and then gently lower the lid.

**TO AVOID DAMAGING THE CABINET OR THE LID, NEVER FORCE THE LID CLOSED. ALWAYS RAISE THE LID TO RELEASE THE LID SUPPORT BRACKET.**

**LOCATION OF CONTROLS AND INDICATORS  
FRONT PANEL**

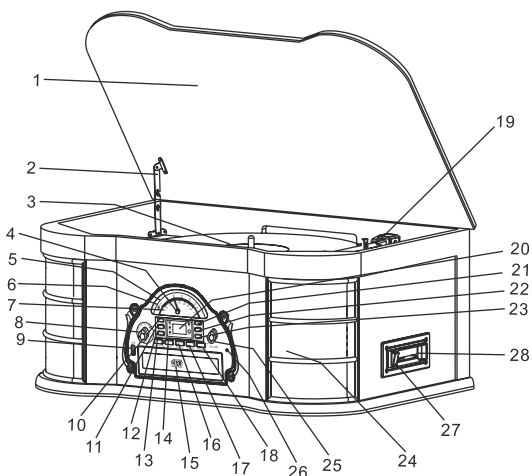
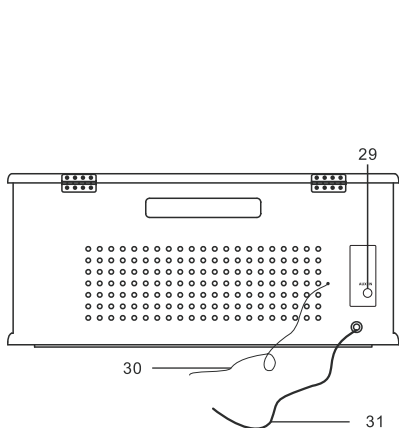

- 1) Phonograph Lid.
- 2) Phonograph Lid Support Bracket.
- 3) Turntable.
- 4) Tuning Control knob.
- 5) FM Dial Scale.
- 6) FM ST. Indicator.
- 7) MW Dial Scale.
- 8) AM/FM/PH/CD/TAPE Function Selector.
- 9) USB Socket.
- 10) RANDOM Control Button.
- 11) REPET Control Button.
- 12) PROGRAM Control Button.
- 13) PLAY/PAUSE Control Button.
- 14) STOP Control Button.
- 15) CD Drawer.
- 16) SKIP REV. Control Button.
- 17) SKIP FWD. Control Button
- 18) OPEN/CLOSE Control Button
- 19) Tone-Arm.
- 20) CD Track Number Display
- 21) REC Control Button
- 22) FOLDER +10 Control Button
- 23) FOLDER -10 Control Button
- 24) Speakers
- 25) OFF-VOLUME Control
- 26) PHONE Jack
- 27) Cassette EJECT/FF Button(Eject/fast Forward)
- 28) Cassette Player Slot
- 29) AUX IN Jack
- 30) FM Antenna
- 31) AC Power Cord

## PHONOGRAPH:

- 1) Turntable
- 2) 45 RPM Adapter
- 3) Transit Screw
- 4) Cue Lever
- 5) Speed Selector (33 / 45 / 78 RPM)
- 6) Tone arm Lock
- 7) Tone arm with Stylus

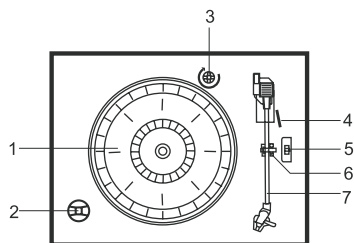

## REMOTE CONTROL OPERATION:

- R1.OPEN / CLOSE
- R2.RECORD
- R3.REPEAT
- R4.PLAY / PAUSE
- R5.DN/FB (SKIP REV)
- R6.DN/FF (SKIP Forward)
- R7.STOP
- R8.TRACK -10
- R9. TRACK +10
- R10.RANDOM
- R11.DELETE
- R12.PROGRAM

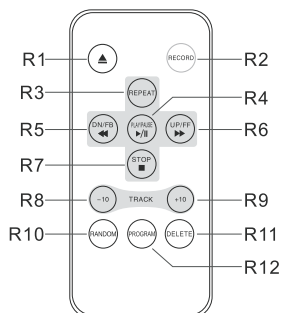

NOTE: ALL of the buttons on the remote control have the same function as these buttons in the unit. This remote control just used for CD/MP3, USB mode.

## OPERATING INSTRUCTIONS

### LISTENING TO THE RADIO

To turn the system on, select the **AM** or **FM** function, adjusting the **TUNING** button to receive stations, when get the clear station, if you tune to strong **FM** Stereo station the **FM ST** indicator lamp will light and reception will be in stereo. If you tune to a weaker FM station, the reception will automatically switch to mono.

### Antenna Information

The **AM** antenna is inside the cabinet. If **AM** reception is unsatisfactory try repositioning the cabinet slightly until the internal antenna is picking up the strongest signal.

The **FM** wire antenna is located on the back of the cabinet. If necessary, adjust the position and direction of this antenna until you find the position that provides the best reception.

**NOTE:**

Level hold **PLAY/PAUSE** button to enter function change as follows: **CD-USB**

When the **CD** function model has not put in **CD / MP3** disc, inserts **USB** card, will automatic switching to **USB** card the playback. To confirm recording successful or not, select the **CD** function and level hold **PLAY/PAUSE** button to enter into **USB** function, insert **USB** card the unit will read the **USB** songs.

**CD/MP3 FUNCTION OPERATION:**

Select to the **CD** function. press the **OPEN/CLOSE** button to open the **CD** door and the unit LCD displays **<OP>**.

1. Place your **CD** or **MP3** disc in the drawer with the printed label side facing up.
2. Press the **OPEN/CLOSE** button once more to close the **CD** door and the unit LCD display **<CLO>**. the disc will spin for a few seconds while the player reads the disc and will automatism playback.

**PLAY CONTROL IN CD/MP3/USB MODEL:**

1. Place your **CD** or **MP3** disc in the drawer or insert **USB** card. Will automatism playback. Play will continue until the end of the **DISC** or **USB** card. When the disc ends, the display again shows the total number of tracks on the disc or **USB** card. You may also stop playback at any time by press the **STOP** button.
2. Adjust the **OFF/VOLUME** control to the desired level.
3. In play model: Press the **SKIP FWD** button on the unit front panel or **UP/FF** button on the remote control to begin the next song.
4. Press the **SKIP REV** button on the unit front panel or **DN/FB** button on the remote control to begin the previous song that has just been played.
5. Press the **FOLDER +10** or **FOLDER -10** button to skip forward or recede 10 tracks in **CD/MP3/USB MODEL**.

**SELECTING THE FOLDER PLAYBACK FOR MP3/USB:**

In stop model: Press **FOLDER +10** or **FOLDER -10** button to selected the **FOLDER+** or **FOLDER-** to confirm the **FOLDER** tracks number. Press **PLAY/PAUSE** button to playback. The song number and folder number of your selected track will be shown consecutively in every 2 seconds. You may also stop playback at any time by press the **STOP** button.

### SELECTING YOUR DESIRED PART FOR CD/MP3/USB:

Depress and hold **SKIP FWD** or **SKIP REV** button on the unit front panel or **UP/FF** or **DN/FB** button on the remote control to select your desired part of the currently playing track and then release the buttons. The playback will resume normal from that point.

### PAUSE CONTROL IN CD/MP3/USB MODEL:

In **CD/MP3/USB** playing mod: Press the **PLAY/PAUSE** button once. Play stops but the disc continues to spin and the LCD indicator of the track number will flash. Press the **PLAY/PAUSE** button once more to cancel pause and of track number stop flashing.

### RECORD CD/MP3/USB/PHONO/CASSETTE FUNCTION:

In **CD/MP3/USB/PHONO** and **CASSETTE** playing mode, select to the desired track songs. Insert **USB** and press **REC** button once, the unit displays **<rEC>**, and the REC indicator lamp will shows. Press **REC** button once more to confirm record to **USB** and the REC indicator lamp will flashes. The unit can be recorded songs for your select favorite songs numbers. If want to cancel press **STOP** button.

**NOTE:** In **PHONO / CASSETTE** model record: To confirm record model, the unit display **<rEC>** and rec indicator lamp will flashes.

### CANCEL USB SONGS OPERATION

The unit plays the song in **USB** : You dislike, pressing and hold the **STOP** button or **DELETE** button on the remote control 2 seconds to cancel, the unit LCD will be displays **<DEL>**.

### REPEAT PLAYBACK IN CD/MP3/USB MODE:

In **CD/MP3/USB** play mode: Press **REPEAT** button once will play the present track repeat playback and the repeat indicator lamp will shows and flashes.

Press the **REPEAT** button second time, will start repeat-all-song and the repeat indicator lamp stop flashes.

To cancel repeat playback: Press the **REPEAT** button third, until the repeat Indicator lamp goes off. Repeat playback is also cancelled by pressing the **STOP** button.



### RANDOM PLAYBACK IN CD/MP3/USB MODE:

In **CD/MP3/USB** play mode: Press **RANDOM** button to start random playing function random indicator lamp will be shown. Press this button again will cancel the random function.

### PROGRAM FUNCTION IN CD/MP3/USB MODE:

This feature allows you to program of the **CD 20** tracks and **MP3/USB 99** tracks on a disc for playback in any desired order.

In **CD/MP3/USB** stop model: Press the **PROGRAM** button to enter the program mode. The program number briefly shows '0 0 1', and the program indicator lamp flash. Press the **SKIP FWD** or **SKIP REV** button on the unit front panel or **UP/FF** or **DN/FB** button on the remote control to select the first track number you wish to enter in the program memory, example: Track number '008'. When the desired track number appears on the display, press the **PROGRAM** button again to memorize the track. The program number briefly shows '0 0 2', then program indicator lamp will shows and flashes.



Repeat step of the above, select a different track number each time until you have entered up to **CD 20** tracks and **MP3/USB 99** tracks in the program memory.

Press the **PLAY/PAUSE** button to begin programmed playback. The **PROGRAM** indicator lamp stop flashing. Playback will begin with the first track you have programmed and will continue until the last programmed track has been played.

The programmed sequence may be cancelled by press **STOP** button twice.



### CASSETTE FUNCTION OPERATION:

1. Select to the **CASSETTE** function. Insert your cassette into the slot, as shown in the illustration, with the side you wish to play facing up and the open end on the right side.

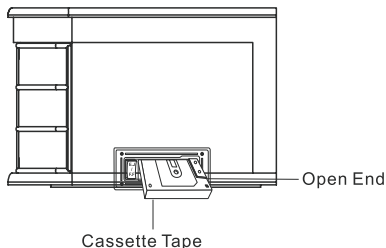

2. Cassette playback begins as soon as the tape is inserted. Adjust the **OFF-VOLUME** control knob to the desired level.

3. To advance the tape rapidly, depress the **EJ/FF** (Eject/Fast Forward) button approximately half way. The tape will move forward rapidly as long as the button is depressed. Normal playback will resume when the button is released.



4. When the tape ends the player stops automatically. Depress the **EJ/FF** (Eject/Fast Forward) button completely to remove the cassette from the player. You may press the **EJ/FF** (Eject/Fast Forward) button to stop play and remove the cassette at any time.



5. To turn the system off, rotate the **OFF-VOLUME** control counter clockwise until a click is heard.



**PHONO FUNCTION OPERATION:**

Select to the PHONO function. Make sure that you have removed the stylus cover from the stylus .

1. Place your PHONO DISC on the center spindle.
2. Adjust the OFF/ VOLUME control to the desired level.

**NOTE:** Do not turn or stop the turntable manually. Moving or jarring the turntable without securing the Tone Arm clamp could result in damage to the Tone Arm.

3. Set the turntable speed selector to the appropriate speed, 33, 45, or 78 RPM. If you are playing 45 RPM singles, place the 45 RPM adapter on the center spindle.
4. To turn the system off, rotate the OFF/VOLUME control knob counter clockwise until a click is heard.
5. When turntable finishes playing, tone arm will return to original position automatically.
6. Move up or move down the speed adjustor to adjust PHONO playing speed. When the Speed display indicates not exact 33 & 45 & 78.

**AUX IN FUNCTION OPERATION:**

Select to the PHONO function. Insert two ends of cord into "AUX IN" socket of unit and corresponding socket of your external device respectively. Operate external device as usual and through the speaker of unit can hear the songs from the external device.

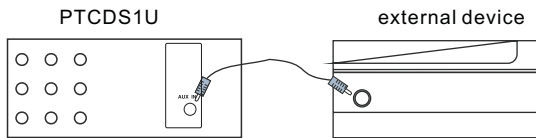

**IMPORTANT!!**

TO PROTECT THE TURNTABLE FROM DAMAGE DURING TRANSPORTATION,

A SILVER TRANSIT SCREW IS LOCATED IN THE UPPER RIGHT CORNER OF THE TURNTABLE PLATFORM.

- BEFORE PLAYING A RECORD, PLEASE USE A SCREWDRIVER OR COIN TO TURN THE TRANSIT SCREW COMPLETELY DOWN IN CLOCKWISE DIRECTION TO UNLOCK THE TURNTABLE.

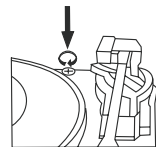

- TO LOCK THE TURNTABLE AGAIN FOR TRANSPORTATION, PLEASE TURN THE SCREW IN COUNTER - CLOCKWISE DIRECTION.

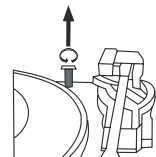

## CASSETTE CARE

Two common causes of trouble experienced when using cassettes are:

- 1) Tape jamming-Leading to uneven speed in playback.
- 2) Tape entangling- the tape wraps itself around vital parts of the mechanism.

To reduce the likelihood of these problems occurring, the following precautions should be observed:

Check that there are no loose layers of tape visible through the cassette centre window (see Fig. 1). Take up any loose layers, using a pencil or hexagonally Barreled ballpoint pen, before inserting the cassette into the machine (see Fig. 2).

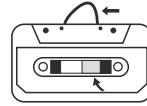

Fig.1

If the cassette feels tight while performing operation shown (see Fig. 2), the tape may be jamming due to ridges formed in the winding of the tape (visible through the centre window). These may be removed in most cases, by fast winding of the cassette from one end to the other and back again.

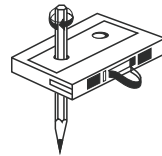
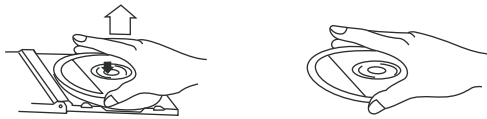

Fig.2

Use only well-known brands of tape. Avoid use of C-120 Cassettes. Furthermore, do not expose cassettes to direct sunlight, dust or oil, and do not touch the tape surfaces.

## COMPACT DISC CARE

To remove a disc from its storage case, press down on the centre of the case and lift the disc out, holding it carefully by the edges.



Fingerprints and dust should be carefully wiped off the disc's recorded surface with a soft cloth. Unlike conventional vinyl or shellac records, compact discs have no grooves to collect dust and microscopic debris, so gently wiping with a soft cloth should remove most particles. Wipe in a straight line from the inside to the outside of the disc. Small dust particles and light stains will have absolutely no effect on sound reproduction quality.

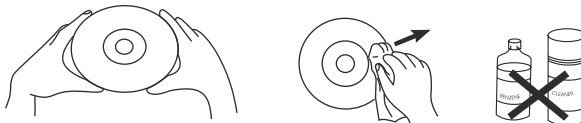

Clean the disc periodically with a soft, lint-free, dry cloth. Never use detergents or abrasive cleaners to clean the disc. If necessary, use a CD cleaning kit.

Never affix labels to the surface of compact discs or write on them, except very gently with specialist CD-R Pens.

## CARE OF THE CABINETS

You should care for the cabinet as you would care for any piece of fine furniture. When the cabinet becomes dusty, wipe it with a soft, non-abrasive dusting cloth. If the cabinet becomes smudged with finger prints, you may use any good quality commercial dusting and polishing spray cleaner. However, avoid spraying the plastic or metal parts of this system. We recommend that you spray the cleaner onto your dusting cloth not directly onto the cabinet to avoid getting any of the spray on the plastic or metal parts.